

JVC

SCHEMATIC DIAGRAMS

COLOUR TELEVISION

BASIC CHASSIS

CH

AV-21L81 (-BK)

CD-ROM No. SML200110

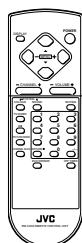

RM-C359-1C

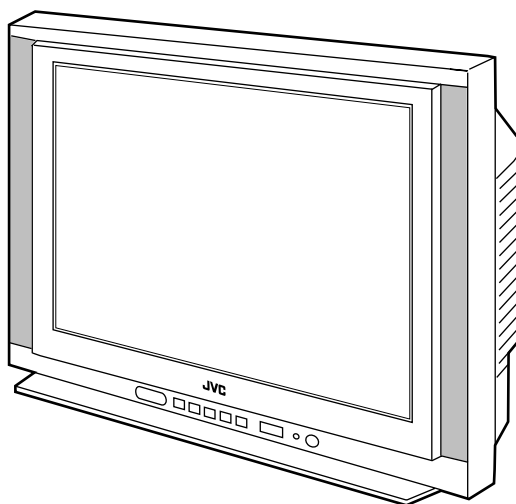

CONTENTS

SEMICONDUCTOR SHAPES 2-2

BLOCK DIAGRAM 2-3

CIRCUIT DIAGRAMS

MAIN PWB CIRCUIT DIAGRAM (1/2) 2-5

MAIN (2/2) AND CRT SOCKET PWB CIRCUIT DIAGRAMS 2-7





PATTERN DIAGRAMS

MAIN PWB PATTERN 2-9

CRT SOCKET PWB PATTERN 2-11

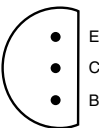
SEMICONDUCTOR SHAPES

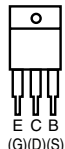
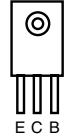
TRANSISTOR

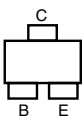
BOTTOM VIEW	FRONT VIEW				TOP VIEW
					CHIP TR 

IC

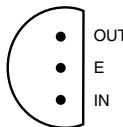
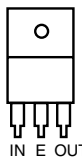
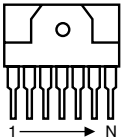
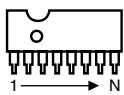
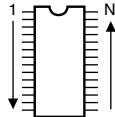
BOTTOM VIEW	FRONT VIEW			TOP VIEW
				

CHIP IC

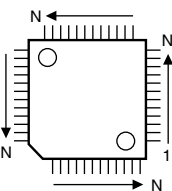
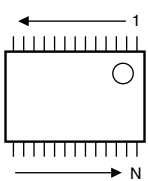
TOP VIEW	
	

BLOCK DIAGRAM

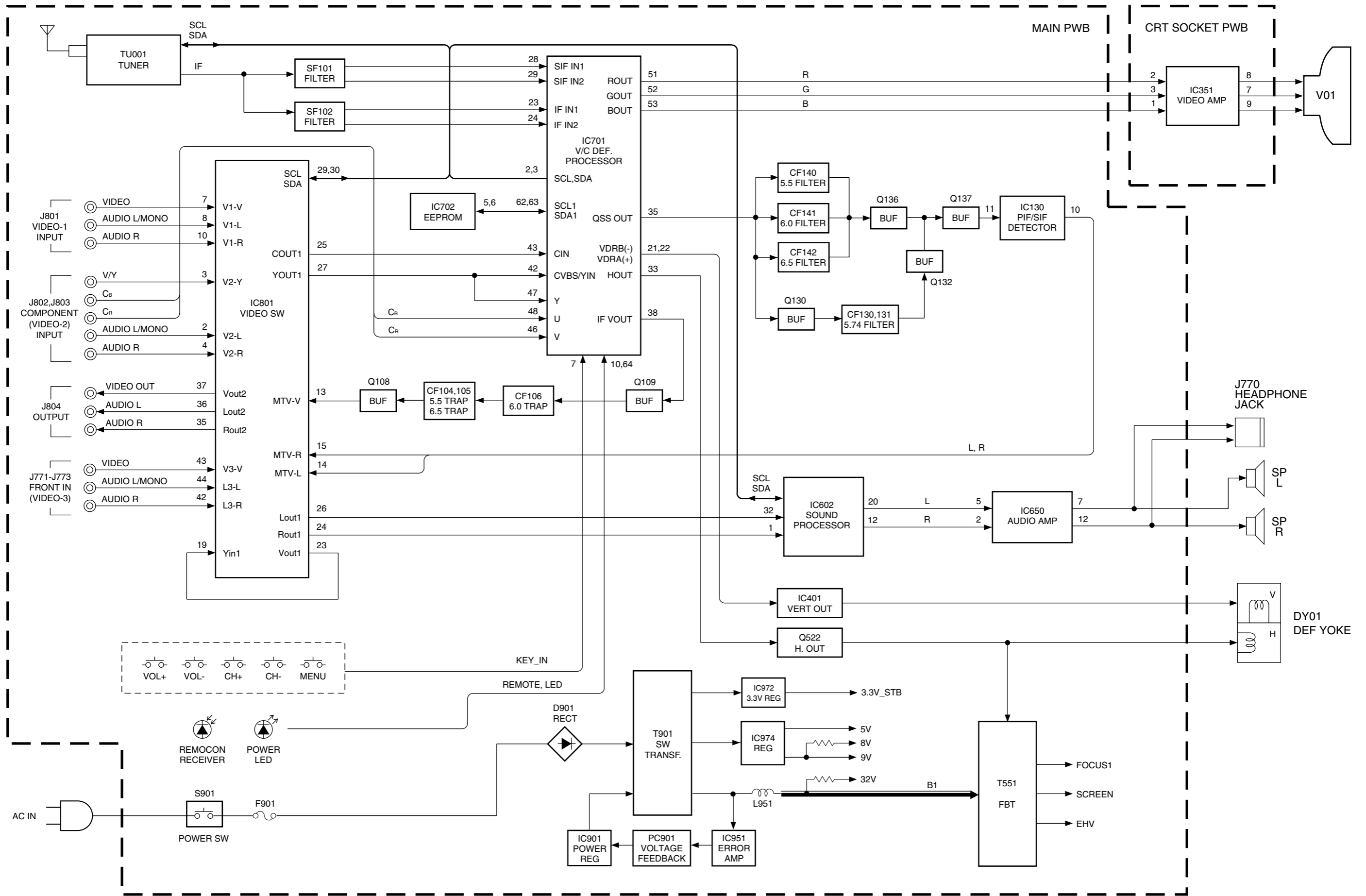

CIRCUIT DIAGRAMS

MAIN PWB CIRCUIT DIAGRAM (1/2)

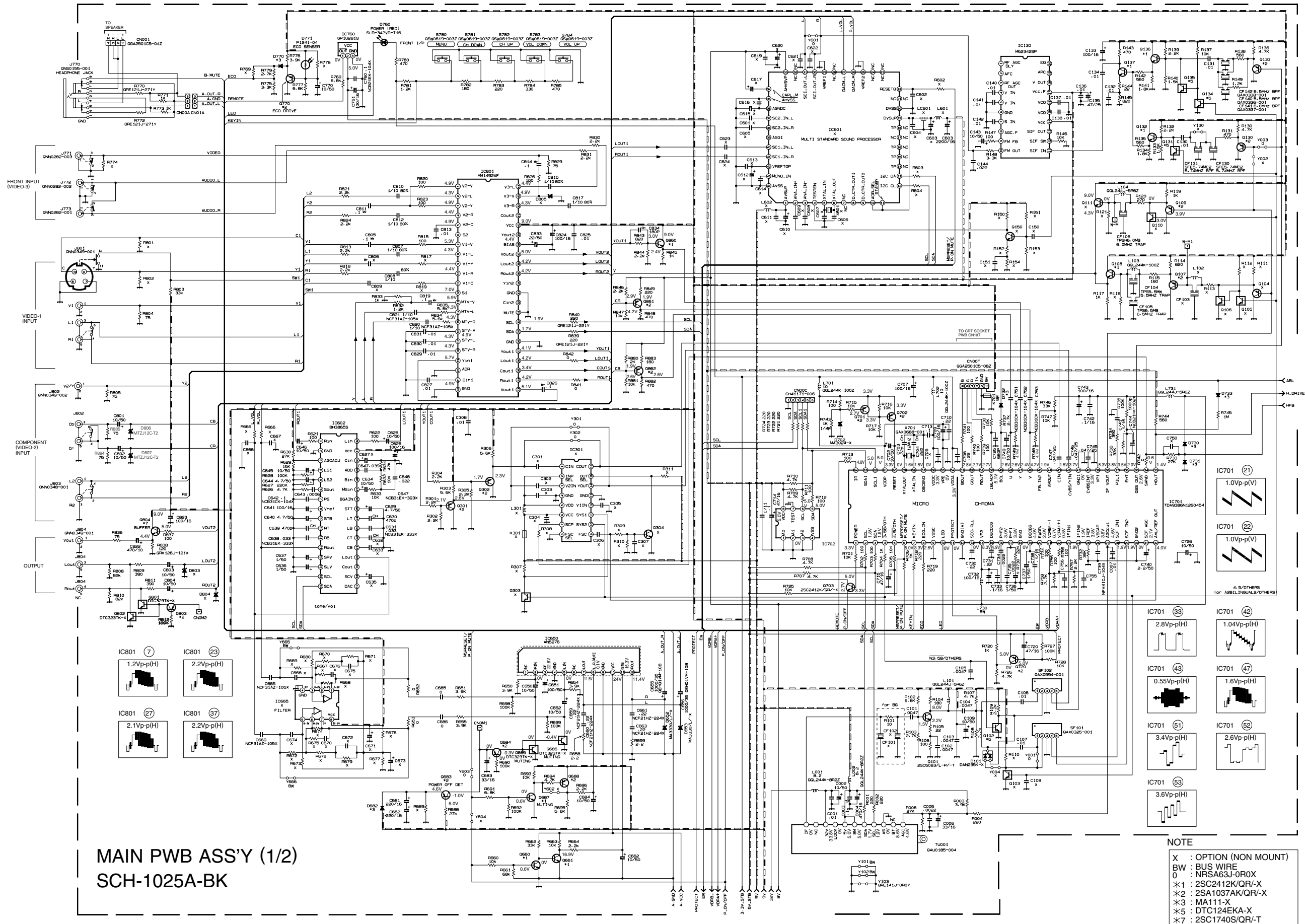

MAIN (2/2) AND CRT SOCKET PWB CIRCUIT DIAGRAMS

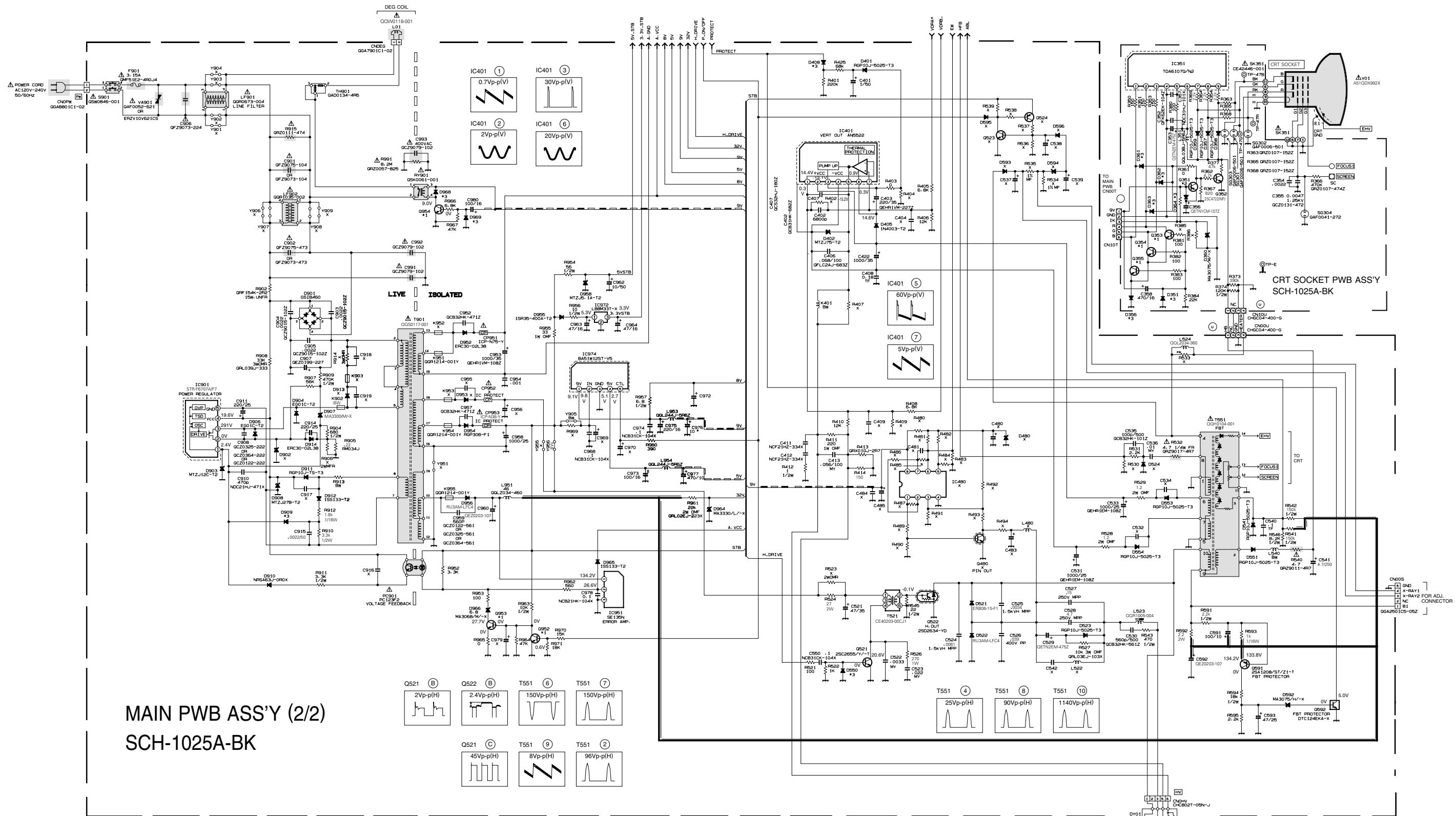

MAIN PWB ASS'Y (2/2)
SCH-1025A-BK

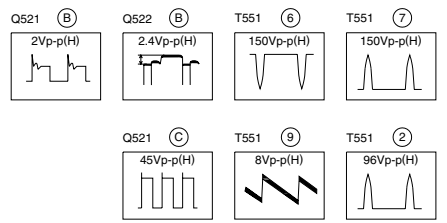

NOTE

- X : OPTION (NON MOUNT)
- BW : BUS WIRE
- 0 : NRSA63J-0R0X
- *1 : 2SC2412K/QR-X
- *2 : 2SA1037AK/QR-X
- *3 : MA111-X

PATTERN DIAGRAMS
MAIN PWB PATTERN

(T) ↓
FRONT

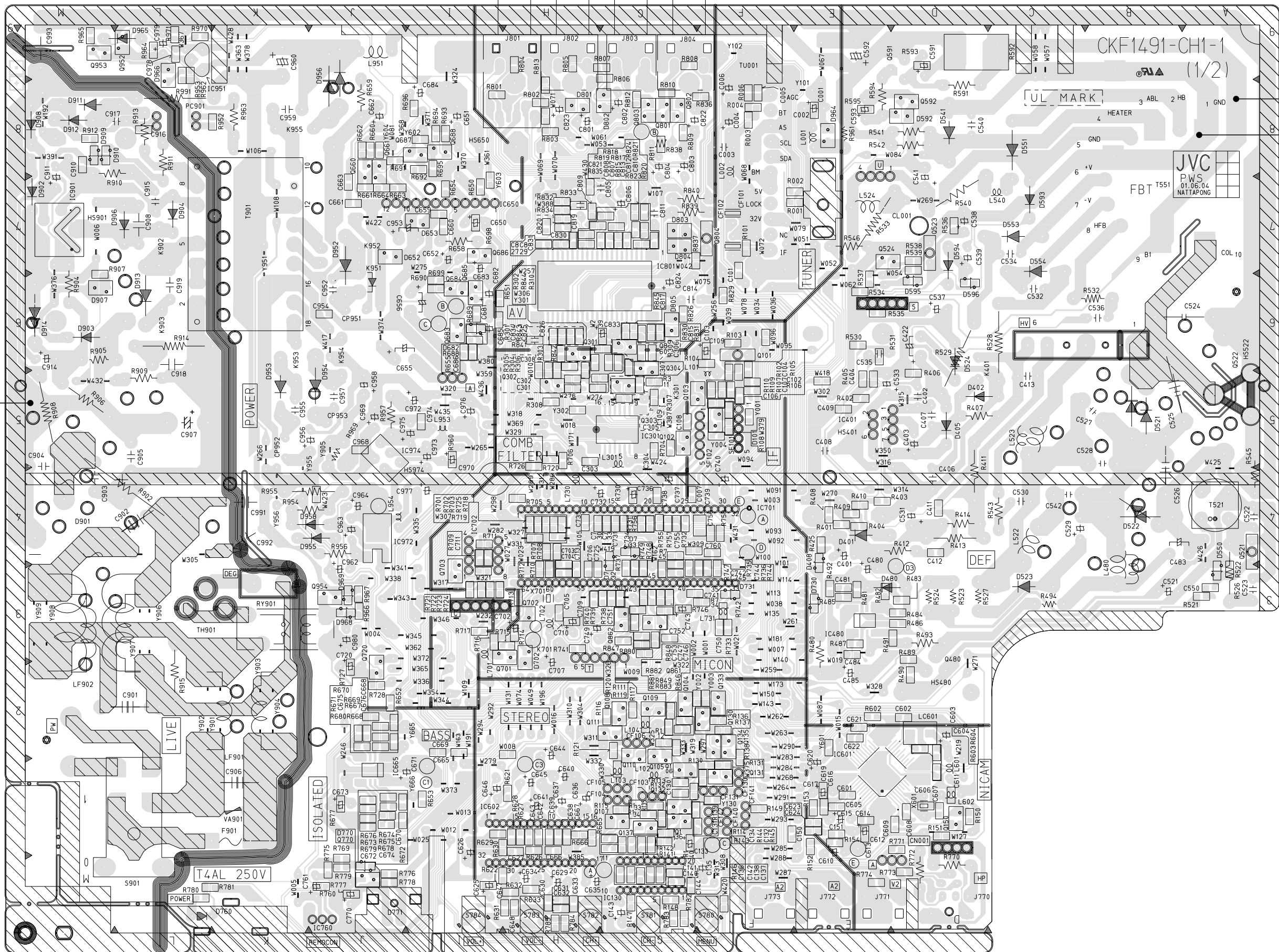

B1
(H)

CRT SOCKET PWB PATTERN

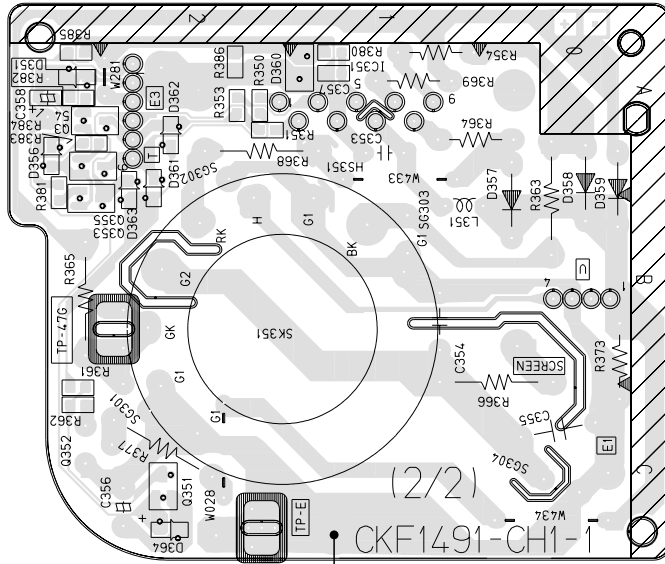

TOP
↑

(H)



JVC

VICTOR COMPANY OF JAPAN, LIMITED

HOME AV NETWORK BUSINESS UNIT 12, 3-chome, Moriya-cho, kanagawa-ku, Yokohama, kanagawa-prefecture, 221-8528, Japan

AV21L81BK-BK #4



Printed in Japan
VP0109
SW